



**2015+ Hellcat Multi-Pump Fuel Hat
Part# SNF-52400**



Caution – EXTREME DANGER – Caution
Do not use or mix any Snow Performance products with any other manufacturer's products.

**THESE INSTRUCTIONS APPLY TO SNOW PERFORMANCE PRODUCTS ONLY!
FOR SANCTIONED RACE USE ONLY - NOT FOR SALE OR USE IN CALIFORNIA**

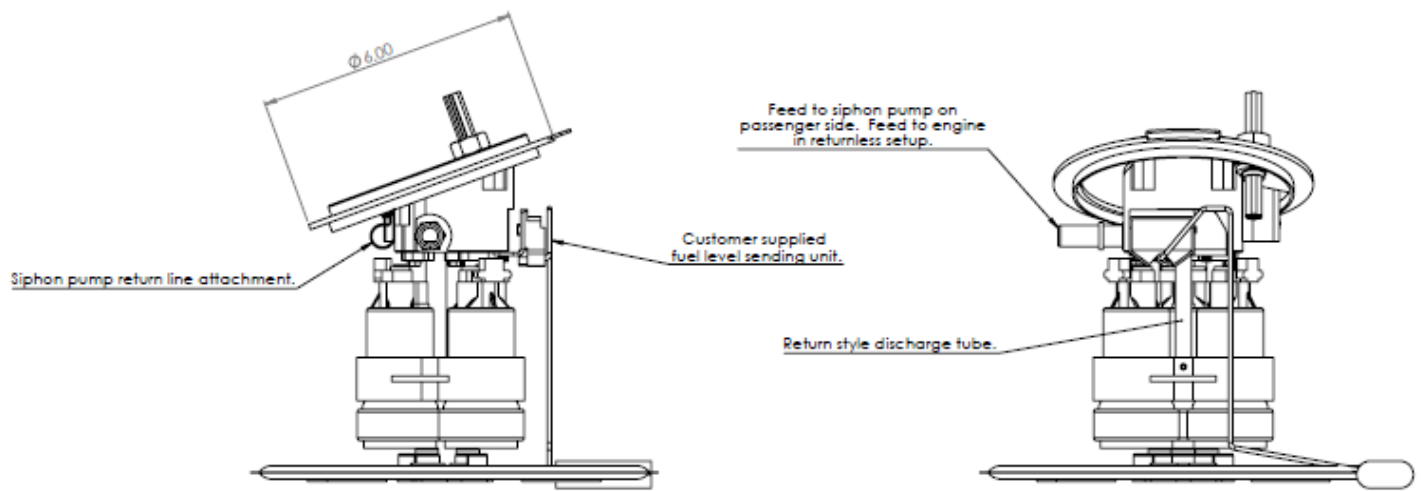

Installation:

1. To reduce spills and make installation easier and safer, the gas tank should be at its lowest level.
2. The fuel pump is underneath the driver side rear seat. Slide the driver seat all the way forward. Pull forward and lift the rear seat out of the vehicle.
3. Remove the seal of the access hole by gently pulling up in a circular fashion.
4. On top of the fuel pump housing unplug the electrical connector.
5. Relieve the pressure in fuel system by starting the engine and allowing it to stall. Remove the gas tank fill cap to relieve any residual tank pressure.
6. Disconnect the battery to ensure a safe working environment when handling items within the fuel system.
7. Clean the top of the factory fuel pump assembly to ensure no foreign materials make their way into the fuel tank.
8. To release the OEM lock ring it is recommended to use the specified fuel tank lock ring tool.

View toward the front of the vehicle

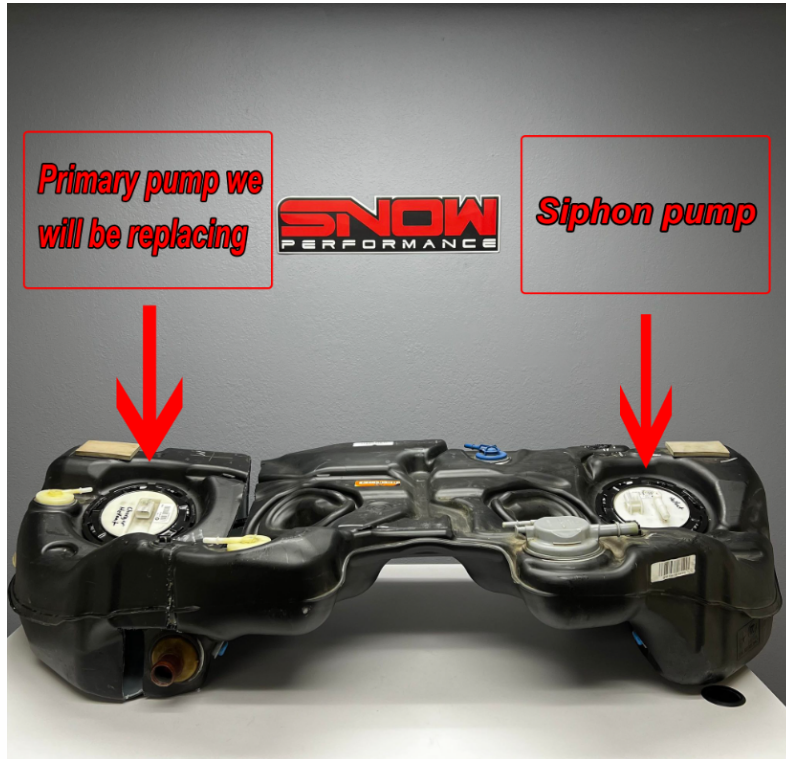

View toward the front of the vehicle



10. The OEM Dodge pump assembly is spring-loaded and will pop up as soon as the lock ring is released.



11. Next, slowly remove the top hat, this will separate from the main body of the pump. The feedline and siphon return line should now be visible, disconnect these from the body of the pump.

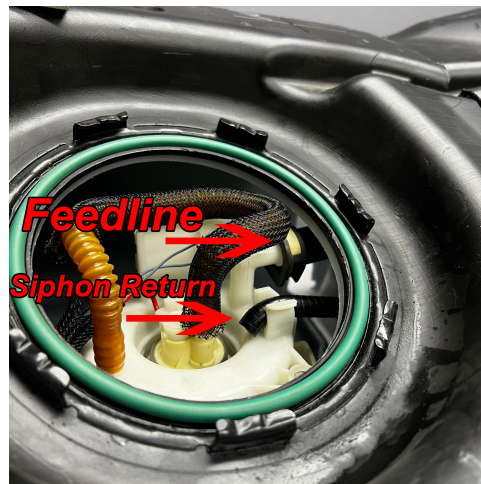

12. Remove the OEM pump assembly being sure not to damage the float arm. Safely drain and contain any residual fuel in the assembly. Inspect the large green seal insuring it is not damaged or compromised.



14. Be sure to cover the opening into the tank to ensure no trash enters the fuel system.
15. Now that the OEM pump assembly has been removed from the car, we will now remove the level sensor from the assembly itself. Press down on the lower right tab and slide the sensor right. The only parts that will be reused are the fuel level sender and the large gasket.



16. Cut the electrical connector off the fuel level sending unit. Keep as much wire slack as possible, and proceed to strip the wires.
17. We will connect the level sensor wires in a fashion similar to its previous state simply by soldering the wires back together and securing the contact with heat shrink. Connect to the White & Blue wires. Wire polarity is not specific to the level sensor.
18. Secure the fuel level sensor by pressing in and sliding it to the left until it clicks it into place on the Snow Performance assembly.

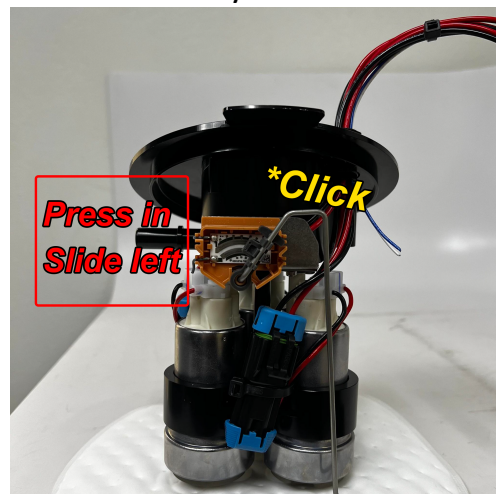

19. To prepare installation of the Snow Fuel Systems assembly, remove cover and locking ring off of the siphon pump on the other side of the tank. This will allow more maneuverability with the hoses to install the Multi-Pump fuel hat.

Siphon Pump



21. Unbolt the top of the new Multi-Pump Fuel Hat to give clearance for connecting the feed-line and siphon return.

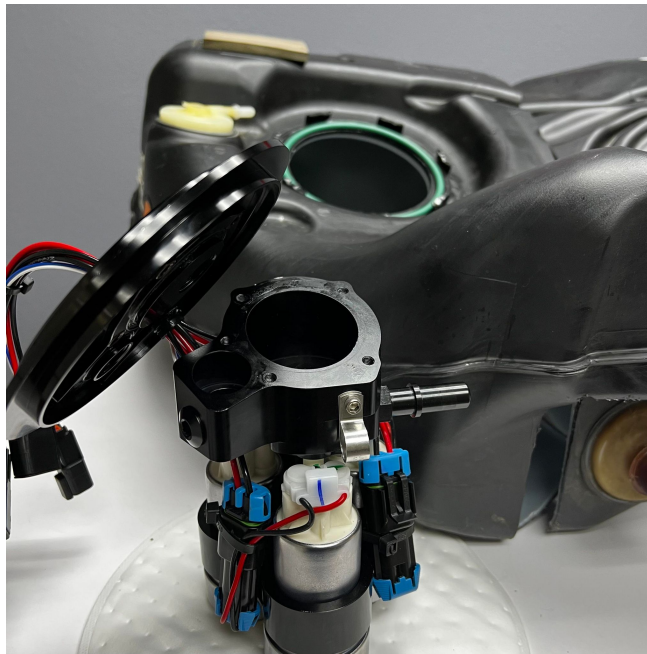

22. Carefully lower the fuel pump assembly. It is normal to have a slight interference with the fuel level sensor. When sliding the fuel level sensor past the tank opening, gently push the sensor inward. For proper orientation, reference the Snow Performance logo or the images that follow.

23. Once the body has been placed inside of the tank, connect the feed-line and siphon return line to the Multi-Pump Fuel hat.

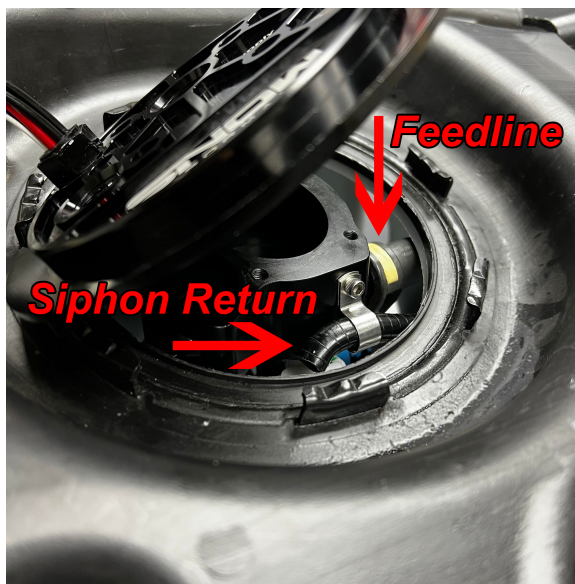

24. With the body properly connected reinstall the top hat bolts and tighten in a cross pattern(58 in/lbs) insuring proper seating of the O-ring.

25. Using the proper tool and socket wrench, reinstall the lock ring on both the main pump and siphon pump, as well as all other connectors.



NOTES:

Factory Returnless Dual Pump only

- If you are using this in a factory returnless setup the "Supply" and "Return" ports on top of the hat must be plugged(SNF-60008, SNF-60009)
- Returnless setups will require a factory fuel pump driver module(FPDM) for each pump. This FPDM and associated wiring harness can be found on Tapped Performance website. <https://tapped-performance.myshopify.com/>

Aftermarket Return Style Dual and Triple Pump Configurations

- Return style setups will require you to plug the factory feed fitting on top of the siphon pumps hat. Then you will run all new feed and return lines to the engine from the Snow Multi-Pump Fuel hat.
- Wiring an aftermarket return setup is recommended and shown below.

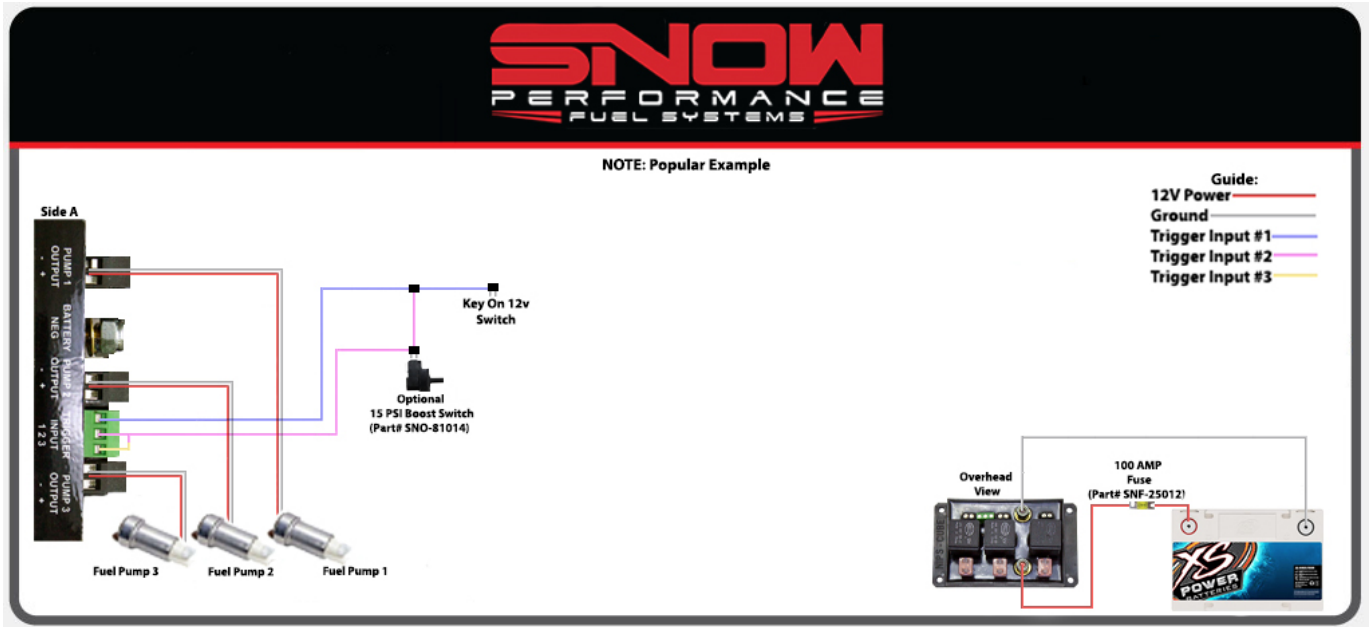

26. Reconnect the battery and turn the ignition key to the ON position. Confirm the new fuel pump(s) prime for a few seconds and inspect the car for leaks. Set base fuel pressure accordingly. If no leaks are found, start the vehicle. The engine may run rough for a few seconds until all the air is bled from the fuel system. Reinstall the OEM cover plate, the rear seat, and you have officially completed the installation!

Popular Routing Example:

